

NOVEMBER  
**2022**  
PRICE LIST



**jainson**  
SINCE 1971



- | P.G CABLE GLANDS
- | H.R.C FUSE FITTING
- | POLYAMIDE FLEXIBLE  
CONDUIT PIPE & GLANDS
- | A.B.S JUNCTION BOX IP-65
- | JUNCTION BOX WITH  
CONNECTORS IP-65
- | LED INDICATOR



### WHITE CABLE GLANDS

HSN CODE - 39174000



**JPG-7**  
PG Thread Cable Glands

|                  |       | PRICE |
|------------------|-------|-------|
| Catalogue No.    | JPG-7 | 4.30  |
| Std. Packing     | 100   |       |
| Master Packing : | 7000  |       |



**JPG-9**  
PG Thread Cable Glands

|                  |       | PRICE |
|------------------|-------|-------|
| Catalogue No.    | JPG-7 | 5.30  |
| Std. Packing     | 100   |       |
| Master Packing : | 5000  |       |



**JPG-11**  
PG Thread Cable Glands

|                  |       | PRICE |
|------------------|-------|-------|
| Catalogue No.    | JPG-7 | 6.80  |
| Std. Packing     | 100   |       |
| Master Packing : | 3500  |       |



**JPG-13.5**  
PG Thread Cable Glands

|                  |       | PRICE |
|------------------|-------|-------|
| Catalogue No.    | JPG-7 | 7.35  |
| Std. Packing     | 100   |       |
| Master Packing : | 3500  |       |



**JPG-16**  
PG Thread Cable Glands

|                  |       | PRICE |
|------------------|-------|-------|
| Catalogue No.    | JPG-7 | 9.00  |
| Std. Packing     | 100   |       |
| Master Packing : | 2500  |       |



**JPG-19**  
PG Thread Cable Glands

|                  |       | PRICE |
|------------------|-------|-------|
| Catalogue No.    | JPG-7 | 12.60 |
| Std. Packing     | 100   |       |
| Master Packing : | 2000  |       |



**JPG-21**  
PG Thread Cable Glands

|                  |       | PRICE |
|------------------|-------|-------|
| Catalogue No.    | JPG-7 | 13.90 |
| Std. Packing     | 100   |       |
| Master Packing : | 1400  |       |



**JPG-25**  
PG Thread Cable Glands

|                  |       | PRICE |
|------------------|-------|-------|
| Catalogue No.    | JPG-7 | 16.50 |
| Std. Packing     | 100   |       |
| Master Packing : | 1200  |       |



**JPG-29**  
PG Thread Cable Glands

|                  |       | PRICE |
|------------------|-------|-------|
| Catalogue No.    | JPG-7 | 24.00 |
| Std. Packing     | 50    |       |
| Master Packing : | 800   |       |



**JPG-36**  
PG Thread Cable Glands

|                  |       | PRICE |
|------------------|-------|-------|
| Catalogue No.    | JPG-7 | 44.00 |
| Std. Packing     | 25    |       |
| Master Packing : | 450   |       |



**JPG-42**  
PG Thread Cable Glands

|                  |       | PRICE |
|------------------|-------|-------|
| Catalogue No.    | JPG-7 | 58.00 |
| Std. Packing     | 25    |       |
| Master Packing : | 300   |       |



**JPG-48**  
PG Thread Cable Glands

|                  |       | PRICE |
|------------------|-------|-------|
| Catalogue No.    | JPG-7 | 64.00 |
| Std. Packing     | 20    |       |
| Master Packing : | 280   |       |



**JPG-63**  
PG Thread Cable Glands

|                  |       | PRICE  |
|------------------|-------|--------|
| Catalogue No.    | JPG-7 | 120.00 |
| Std. Packing     | 12    |        |
| Master Packing : | 120   |        |

### BLACK CABLE GLANDS

HSN CODE - 39174000



**JPG-7**  
PG Thread Cable Glands

|                  |       | PRICE |
|------------------|-------|-------|
| Catalogue No.    | JPG-7 | 4.30  |
| Std. Packing     | 100   |       |
| Master Packing : | 2500  |       |



**JPG-9**  
PG Thread Cable Glands

|                  |       | PRICE |
|------------------|-------|-------|
| Catalogue No.    | JPG-9 | 5.30  |
| Std. Packing     | 100   |       |
| Master Packing : | 2500  |       |



**JPG-11**  
PG Thread Cable Glands

|                  |        | PRICE |
|------------------|--------|-------|
| Catalogue No.    | JPG-11 | 6.80  |
| Std. Packing     | 100    |       |
| Master Packing : | 3500   |       |



**JPG-13.5**  
PG Thread Cable Glands

|                  |          | PRICE |
|------------------|----------|-------|
| Catalogue No.    | JPG-13.5 | 7.35  |
| Std. Packing     | 100      |       |
| Master Packing : | 1500     |       |



**JPG-16**  
PG Thread Cable Glands

|                  |        | PRICE |
|------------------|--------|-------|
| Catalogue No.    | JPG-16 | 9.00  |
| Std. Packing     | 100    |       |
| Master Packing : | 2500   |       |



**JPG-19**  
PG Thread Cable Glands

|                  |        | PRICE |
|------------------|--------|-------|
| Catalogue No.    | JPG-19 | 12.60 |
| Std. Packing     | 100    |       |
| Master Packing : | 2000   |       |

### METRIC THREADED CABLE GLANDS

HSN CODE - 39174000



**JPGM-12**  
Metric Thread Cable Glands

|                  |               | PRICE |
|------------------|---------------|-------|
| Catalogue No.    | JPGM-12mmX1.5 | 5.50  |
| Std. Packing     | 100           |       |
| Master Packing : | 2500          |       |



**JPGM-16**  
Metric Thread Cable Glands

|                  |               | PRICE |
|------------------|---------------|-------|
| Catalogue No.    | JPGM-16mmX1.5 | 6.50  |
| Std. Packing     | 100           |       |
| Master Packing : | 2500          |       |



**JPGM-20**  
Metric Thread Cable Glands

|                  |               | PRICE |
|------------------|---------------|-------|
| Catalogue No.    | JPGM-20mmX1.5 | 8.00  |
| Std. Packing     | 100           |       |
| Master Packing : | 2500          |       |



**JPGM-25**  
Metric Thread Cable Glands

|                  |               | PRICE |
|------------------|---------------|-------|
| Catalogue No.    | JPGM-25mmX1.5 | 16.00 |
| Std. Packing     | 100           |       |
| Master Packing : | 2500          |       |



**JPGM-32**  
Metric Thread Cable Glands

|                  |               | PRICE |
|------------------|---------------|-------|
| Catalogue No.    | JPGM-32mmX1.5 | 25.00 |
| Std. Packing     | 100           |       |
| Master Packing : | 2500          |       |



**JPG-7-12mm**  
PG Thread Cable Glands

|                  |            | PRICE |
|------------------|------------|-------|
| Catalogue No.    | JPG-7-12mm | 6.25  |
| Std. Packing     | 100        |       |
| Master Packing : | 2500       |       |



**JPG-7-15mm**  
PG Thread Cable Glands

|                  |            | PRICE |
|------------------|------------|-------|
| Catalogue No.    | JPG-7-15mm | 7.25  |
| Std. Packing     | 100        |       |
| Master Packing : | 2500       |       |



**JPG-9-12mm**  
PG Thread Cable Glands

|                  |            | PRICE |
|------------------|------------|-------|
| Catalogue No.    | JPG-9-12mm | 9.00  |
| Std. Packing     | 100        |       |
| Master Packing : | 2500       |       |



**JPG-9-15mm**  
PG Thread Cable Glands

|                  |            | PRICE |
|------------------|------------|-------|
| Catalogue No.    | JPG-9-15mm | 10.00 |
| Std. Packing     | 100        |       |
| Master Packing : | 2500       |       |

CABLE GLANDS HSN CODE - 39174000

WATER PROOF JUNCTION BOX - ABS WITHOUT GOURMET
HSN CODE - 85359040



### JJB-100

Dimension :  
100mm x 100mm x 70mm

|                  |         | PRICE |
|------------------|---------|-------|
| Catalogue No.    | JJB-100 | 83.00 |
| Master Packing : | 180     |       |



### JJB-150110

Dimension :  
150mm x 110mm x 70mm

|                  |            | PRICE  |
|------------------|------------|--------|
| Catalogue No.    | JJB-150110 | 142.00 |
| Master Packing : | 110        |        |



### JJB-150

Dimension :  
150mm x 150mm x 70mm

|                  |         | PRICE  |
|------------------|---------|--------|
| Catalogue No.    | JJB-150 | 165.00 |
| Master Packing : | 80      |        |



### JJB-200

Dimension :  
200mm x 155mm x 80mm

|                  |         | PRICE  |
|------------------|---------|--------|
| Catalogue No.    | JJB-200 | 220.00 |
| Master Packing : | 56      |        |



### JJB-255

Dimension :  
255mm x 200mm x 80mm

|                  |         | PRICE  |
|------------------|---------|--------|
| Catalogue No.    | JJB-255 | 320.00 |
| Master Packing : | 36      |        |



### JJB-300

Dimension :  
300mm x 250mm x 120mm

|                  |         | PRICE  |
|------------------|---------|--------|
| Catalogue No.    | JJB-300 | 600.00 |
| Master Packing : | 20      |        |



### JJB-400

Dimension :  
400mm x 350mm x 120mm

|                  |         | PRICE   |
|------------------|---------|---------|
| Catalogue No.    | JJB-400 | 1400.00 |
| Master Packing : | 10      |         |

CAMERA BOX HSN CODE - 85359040



### JCB-01

Dimension :  
100mm x 100mm x 70mm

|                  |        | PRICE |
|------------------|--------|-------|
| Catalogue No.    | JCB-01 | 59.00 |
| Master Packing : | 180    |       |

JUNCTION BOX WITHOUT CONNECTOR IP-65

HSN CODE - 85359040



**JJB-9020**

Dimension :  
88mm x 88mm x 53mm

|                  |          | PRICE  |
|------------------|----------|--------|
| Catalogue No.    | JJB-9020 | 145.00 |
| Master Packing : | 175      | ---    |



**JJB-9040**

Dimension :  
98mm x 98mm x 61mm

|                  |          | PRICE  |
|------------------|----------|--------|
| Catalogue No.    | JJB-9040 | 160.00 |
| Master Packing : | 150      | ---    |



**JJB-9060**

Dimension :  
139mm x 119mm x 70mm

|                  |          | PRICE  |
|------------------|----------|--------|
| Catalogue No.    | JJB-9060 | 250.00 |
| Master Packing : | 100      | ---    |



**JJB-9100**

Dimension :  
167mm x 125mm x 82mm

|                  |          | PRICE  |
|------------------|----------|--------|
| Catalogue No.    | JJB-9100 | 370.00 |
| Master Packing : | 50       | ---    |

JUNCTION BOX WITH CONNECTOR IP-65 (WITH BRASS CONTACT)

HSN CODE - 85359040



**JJB-9020J**

Dimension :  
88mm x 88mm x 53mm  
Size : 2.5 sq. mm

|                  |           | PRICE  |
|------------------|-----------|--------|
| Catalogue No.    | JJB-9020J | 185.00 |
| Master Packing : | 175       | ---    |



**JJB-9040J**

Dimension :  
98mm x 98mm x 61mm  
Size : 4-6 sq. mm

|                  |           | PRICE  |
|------------------|-----------|--------|
| Catalogue No.    | JJB-9040J | 205.00 |
| Master Packing : | 150       | ---    |



**JJB-9060J**

Dimension :  
139mm x 119mm x 70mm  
Size : 10 sq. mm

|                  |           | PRICE  |
|------------------|-----------|--------|
| Catalogue No.    | JJB-9060J | 325.00 |
| Master Packing : | 100       | ---    |



**JJB-9100J**

Dimension :  
167mm x 125mm x 82mm  
Size : 16 sq. mm

|                  |           | PRICE  |
|------------------|-----------|--------|
| Catalogue No.    | JJB-9100J | 620.00 |
| Master Packing : | 50        | ---    |

### POLY AMID FLEXIBLE CONDUCT GLAND

HSN CODE - 39174000

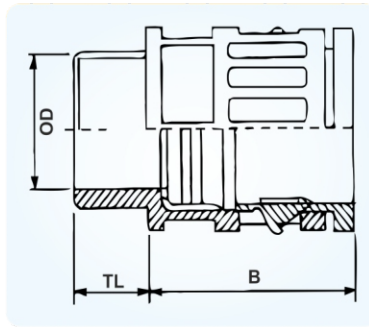

#### Technical Details :

|                   |                                     |
|-------------------|-------------------------------------|
| Material          | Polyamide PA - 6 - V - 2            |
| Temperature Range | -40°C to +105°C<br>Short Term 150°C |

| CAT NO. BLACK | A D SIZE | THREAD (OD) mm | PIPE (OD) mm | Thread Length mm | (B) mm | PRICE LIST | STD. PKG |
|---------------|----------|----------------|--------------|------------------|--------|------------|----------|
| JCG - 7       | 10       | 12.3           | 6.5          | 11               | 18.7   | 14.50      | 100      |
| JCG - 9       | 13       | 15             | 10           | 11               | 21.7   | 15.00      | 100      |
| JCG - 11      | 15.8     | 18.4           | 12.5         | 11               | 26     | 17.00      | 100      |
| JCG - 13.5    | 18.4     | 20.2           | 14.3         | 11               | 28     | 20.00      | 100      |
| JCG - 16      | 21.2     | 22.3           | 17.0         | 13               | 32     | 25.00      | 100      |
| JCG - 21      | 28.5     | 28             | 23           | 16               | 39.5   | 35.00      | 50       |
| JCG - 29      | 34.5     | 36.7           | 29           | 16               | 46.5   | 50.00      | 25       |
| JCG - 36      | 42.5     | 46.7           | 36           | 16               | 55.5   | 65.00      | 25       |

### POLYAMID FLEXIBLE CONDUCT PIPE

HSN CODE - 39173100

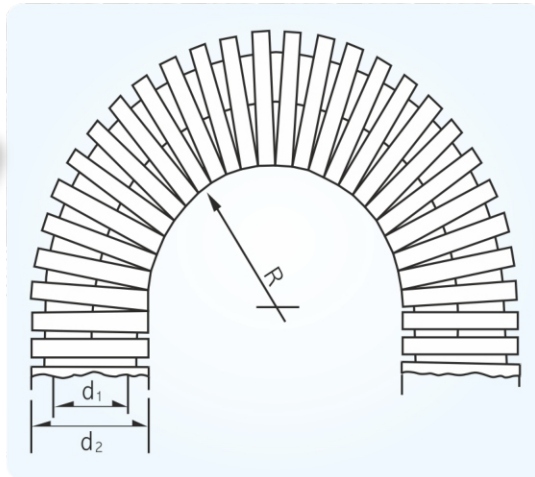

#### Technical Details :

|                   |   |
|-------------------|---|
| Material          | Polyamide PA - 6 - V - 2                        |
| Tensile Strength  | 750 N   |
| Impact Strength   | (+23°C) > 20 J (-15°C) > 6 J                    |
| Temperature Range | -40°C to +120°C Continuous,<br>Short Term 150°C |

| CAT NO. BLACK | A D SIZE | INNER DIAMETER d1 (mm) | OUTER DIAMETER d2 (mm) | BENDING RADIUS R (mm) ± 10% | PRICE/MTR | PACKING/MTR | ROLL/STD PACK |
|---------------|----------|------------------------|------------------------|-----------------------------|-----------|-------------|---------------|
| JCP - 7       | 10       | 6.5                    | 10.0                   | 20                          | 22.00     | 100         | 16            |
| JCP - 9       | 13       | 10                     | 13.0                   | 30                          | 24.00     | 100         | 10            |
| JCP - 11      | 15.8     | 12                     | 15.8                   | 40                          | 33.00     | 50          | 10            |
| JCP - 13.5    | 18.4     | 14.3                   | 18.5                   | 42                          | 38.00     | 50          | 10            |
| JCP - 16      | 21.2     | 16.5                   | 21.2                   | 45                          | 45.00     | 50          | 10            |
| JCP - 21      | 28.5     | 23.5                   | 28.5                   | 55                          | 70.00     | 50          | 8             |
| JCP - 29      | 34.5     | 29                     | 34.5                   | 60                          | 90.00     | 25          | 6             |
| JCP - 36      | 42.5     | 36                     | 42.5                   | 65                          | 135.00    | 25          | 6             |

### H.R.C. FUSE FITTING (FRONT CONNECTION)

HSN CODE - 85361020

JFC-20A



20 Amp - 415 V

|                      |                | PRICE |
|----------------------|----------------|-------|
| <b>Catalogue No.</b> | <b>JFC-20A</b> | 86.00 |
| Standard Packing :   | 10             |       |
| Master Packing :     | 400            |       |

JFC-32A



32 Amp - 500 V

|                      |                | PRICE  |
|----------------------|----------------|--------|
| <b>Catalogue No.</b> | <b>JFC-32A</b> | 190.00 |
| Standard Packing :   | 10             |        |
| Master Packing :     | 144            |        |

JFC-63A



63 Amp - 500 V

|                      |                | PRICE  |
|----------------------|----------------|--------|
| <b>Catalogue No.</b> | <b>JFC-63A</b> | 280.00 |
| Standard Packing :   | 5              |        |
| Master Packing :     | 120            |        |

JFC-125A



125 Amp - 500 V

|                      |                 | PRICE  |
|----------------------|-----------------|--------|
| <b>Catalogue No.</b> | <b>JFC-125A</b> | 690.00 |
| Standard Packing :   | 3               |        |
| Master Packing :     | 30              |        |

### LED INDICATOR LAMP

HSN CODE - 85361020

22.5mm



Colour :  
Red, Green, Yellow,  
Blue, White

|                      |                 | PRICE |
|----------------------|-----------------|-------|
| <b>Catalogue No.</b> | <b>JLI-22.5</b> | 46.00 |
| Standard Packing :   | 10              |       |
| Master Packing :     | 1000            |       |

### UNDER DEVELOPMENT



UNDER DEVELOPMENT  
PUSH BUTTON BOX



## Dealer's and Stockist of :



**All Electrical needs under one Roof  
Everything in Electrical Goods**

### HEAD OFFICE

251-A/3B, 2nd Floor,  
Mangaldas Building, Luhar Chawl,  
Mangaldas Road, Mumbai - 400 002.  
Tel. : 022-40060261

### BHOSARI BRANCH

Shop -10, Jay Tulja Bhavani Complex,  
Plot No. BG 74A, Opp. Century Enka,  
Telco Road, MIDC Bhosari, Pune - 411026.  
E-mail : reliablepune26@gmail.com

### CHAKAN BRANCH

Plot No.A-15, Phase-II,  
MIDC Chakan Industrial area,  
Near Hyundai, Sawardhari, Taluka Khed,  
Dist. Pune-410501.  
E-mail : info@reliablepune.com

### CUSTOMER CARE :

+91 020 27110099  
customer@reliablepune.com